

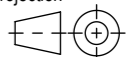

NOTE: This document is property of the company TOPTICA Photonics AG. All copyrights, trademarks, patents and other rights in connection herewith are expressly reserved to the company TOPTICA Photonics AG and no license is created hereby.

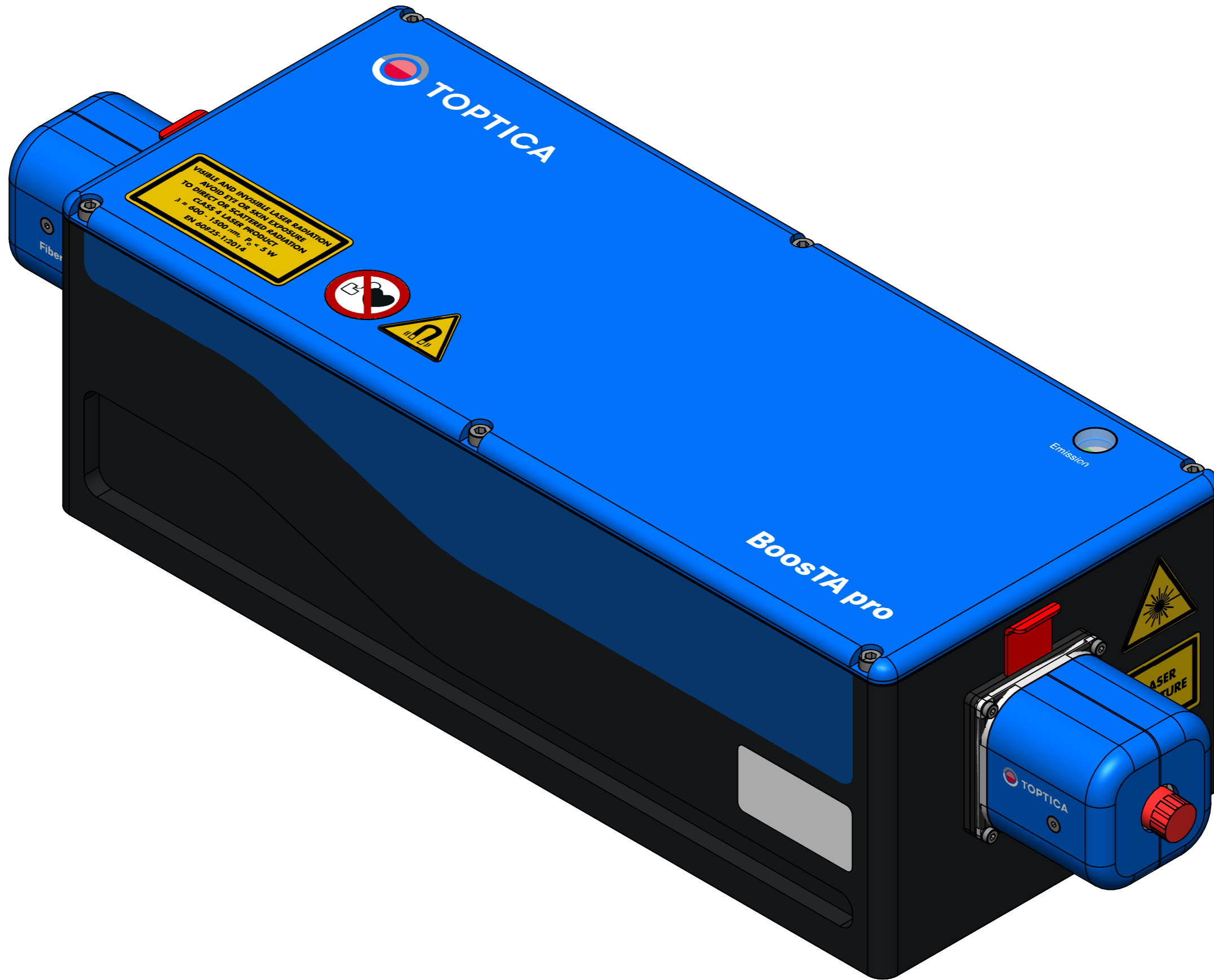

		title		scale
		BoostA pro		1:1
<small>TOPTICA Photonics AG Tel.: 089-85837-0 Lochamer Schlag 19 Fax.: 089-85837-200 82166 Grafelfing Web: www.toptica.com</small>		format		A3
dimensions are in mm	general tolerance	projection	date	sheet
view 3D	DIN ISO 2768 - mK		Datum	1/8

NOTE: This document is property of the company TOPTICA Photonics AG. All copyrights, trademarks, patents and other rights in connection herewith are expressly reserved to the company TOPTICA Photonics AG and no license is created hereby.

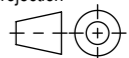

		title		scale
		BoostA pro		1:1
<small>TOPTICA Photonics AG Tel.: 089-85837-0 Lochhamer Schlag 19 Fax.: 089-85837-200 82166 Grafelfing Web: www.toptica.com</small>		format	sheet	
dimensions are in mm	general tolerance	projection	date	2/8
view 3D FD	DIN ISO 2768 - mK		20.03.2024	

NOTE: This document is property of the company TOPTICA Photonics AG. All copyrights, trademarks, patents and other rights in connection herewith are expressly reserved to the company TOPTICA Photonics AG and no license is created hereby.

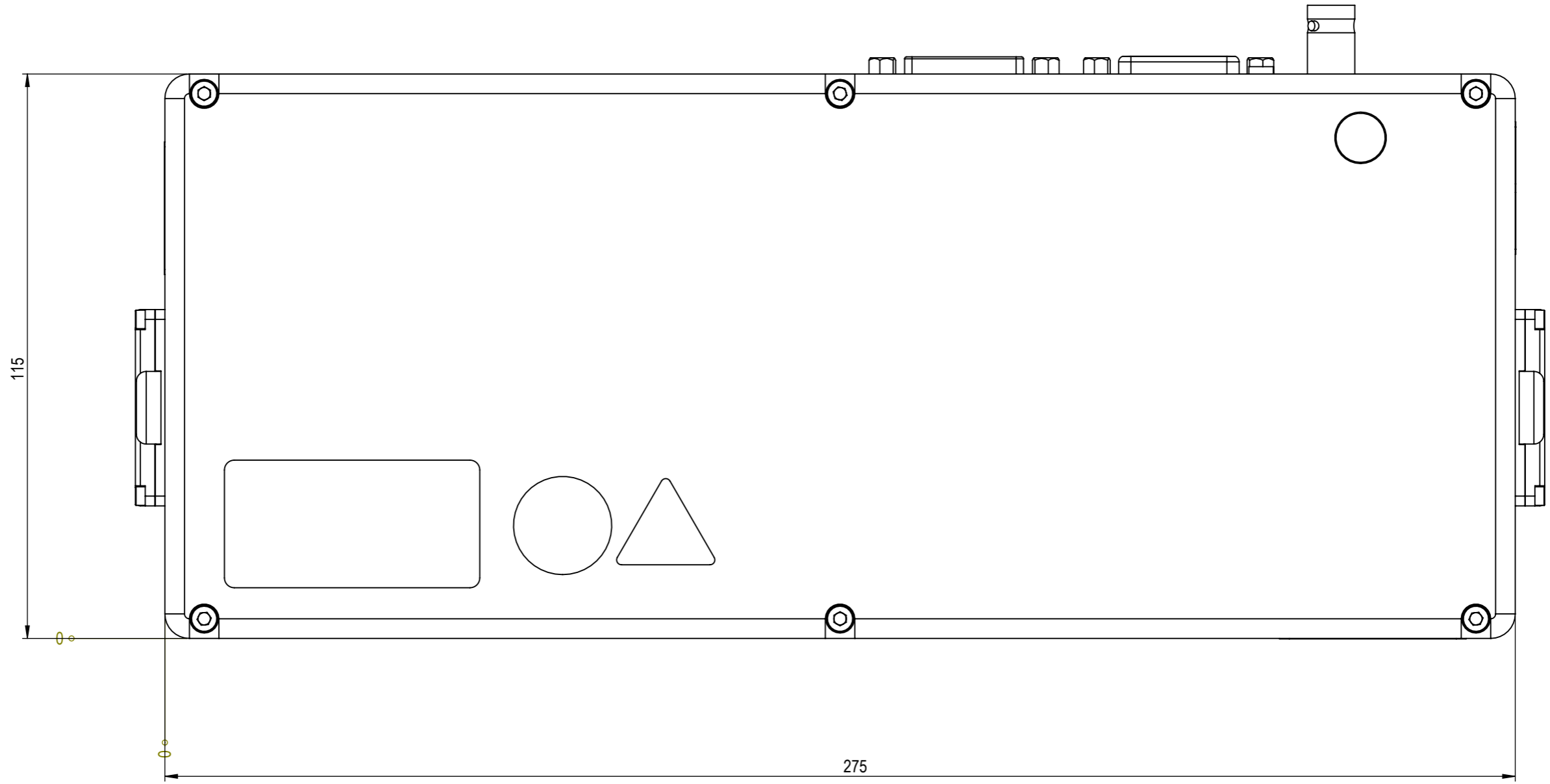

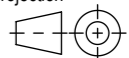
	title		scale
	BoosTA pro		1:1
<small>TOPTICA Photonics AG Tel.: 089-85837-0 Lochhamer Schlag 19 Fax.: 089-85837-200 82166 Grafelfing Web: www.toptica.com</small>	general tolerance	projection	format
<small>dimensions are in mm</small> view TOP	DIN ISO 2768 - mK		A3
	date	sheet	
	20.03.2024	3/8	

NOTE: This document is property of the company TOPTICA Photonics AG. All copyrights, trademarks, patents and other rights in connection herewith are expressly reserved to the company TOPTICA Photonics AG and no license is created hereby.

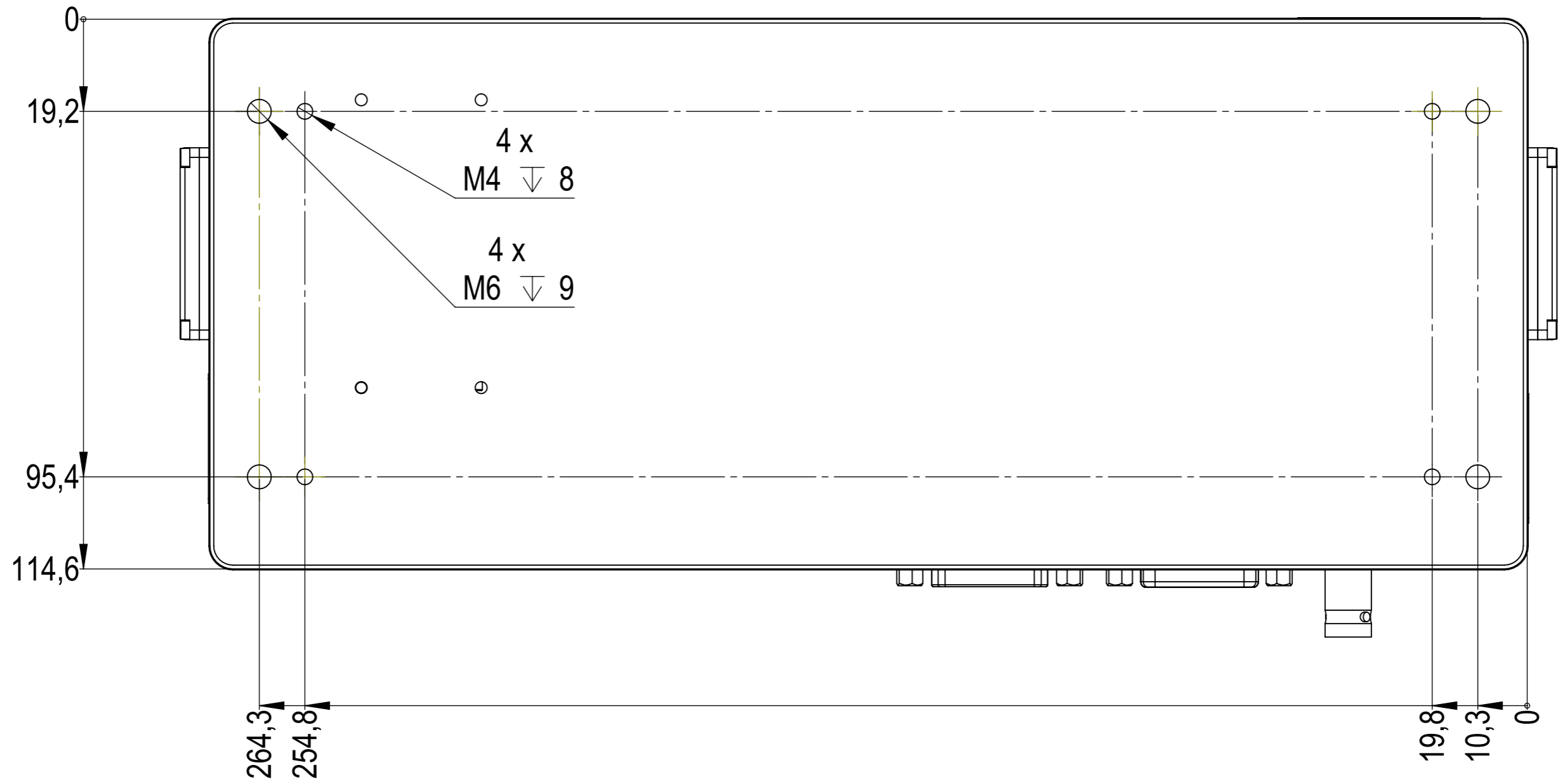

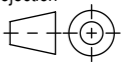
	title	scale
	BoosTA pro	1:1
<small>TOPTICA Photonics AG Tel.: 089-85837-0 Lochhamer Schlag 19 Fax.: 089-85837-200 82166 Grafelfing Web: www.toptica.com</small>	format	A3
dimensions are in mm view BOTTOM	general tolerance DIN ISO 2768 - mK	projection 
	date 20.03.2024	sheet 4/8

NOTE: This document is property of the company TOPTICA Photonics AG. All copyrights, trademarks, patents and other rights in connection herewith are expressly reserved to the company TOPTICA Photonics AG and no license is created hereby.

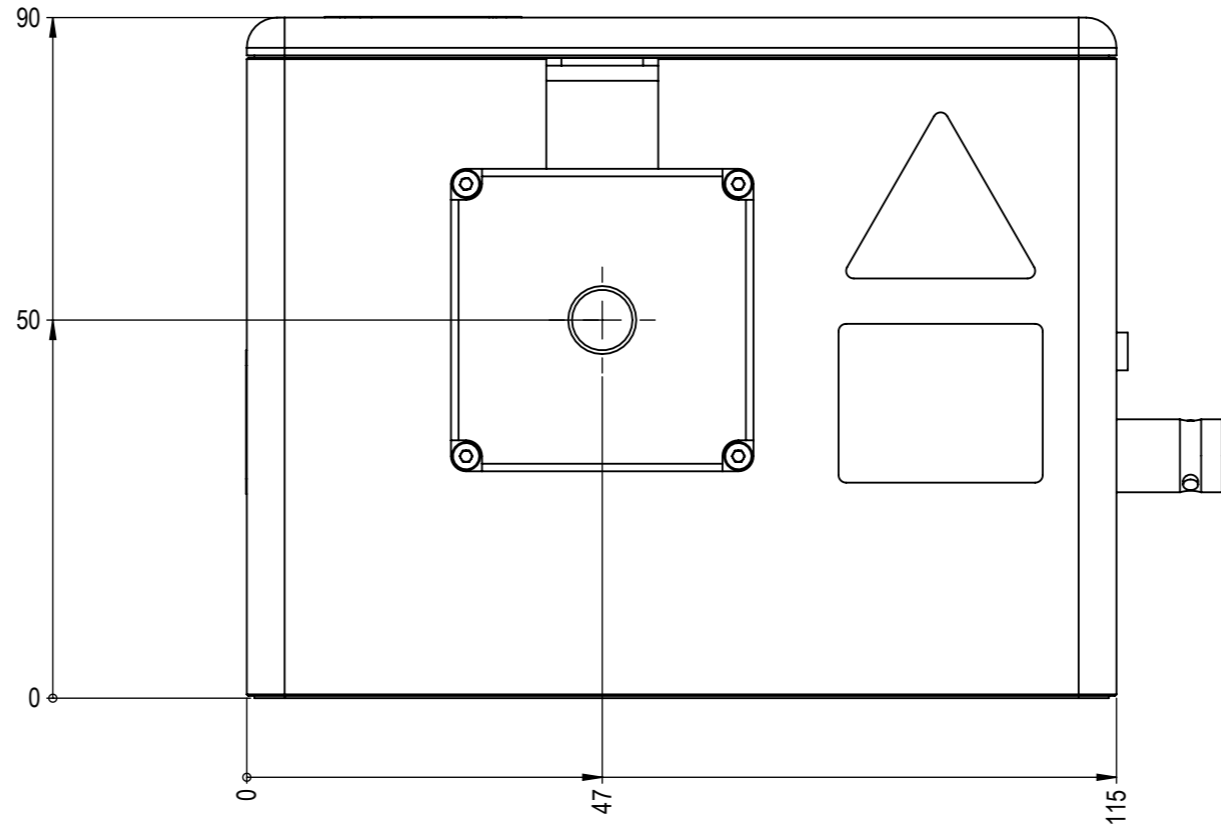

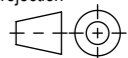
 <small>TOPTICA Photonics AG Tel.: 089-85837-0 Lochhamer Schlag 19 Fax.: 089-85837-200 82166 Grafelfing Web: www.toptica.com</small>	title	scale
	BoosTA pro	1:1
	format	A3
dimensions are in mm	general tolerance	projection
view FRONT	DIN ISO 2768 - mK	
	date	sheet
	20.03.2024	5/8

NOTE: This document is property of the company TOPTICA Photonics AG. All copyrights, trademarks, patents and other rights in connection herewith are expressly reserved to the company TOPTICA Photonics AG and no license is created hereby.

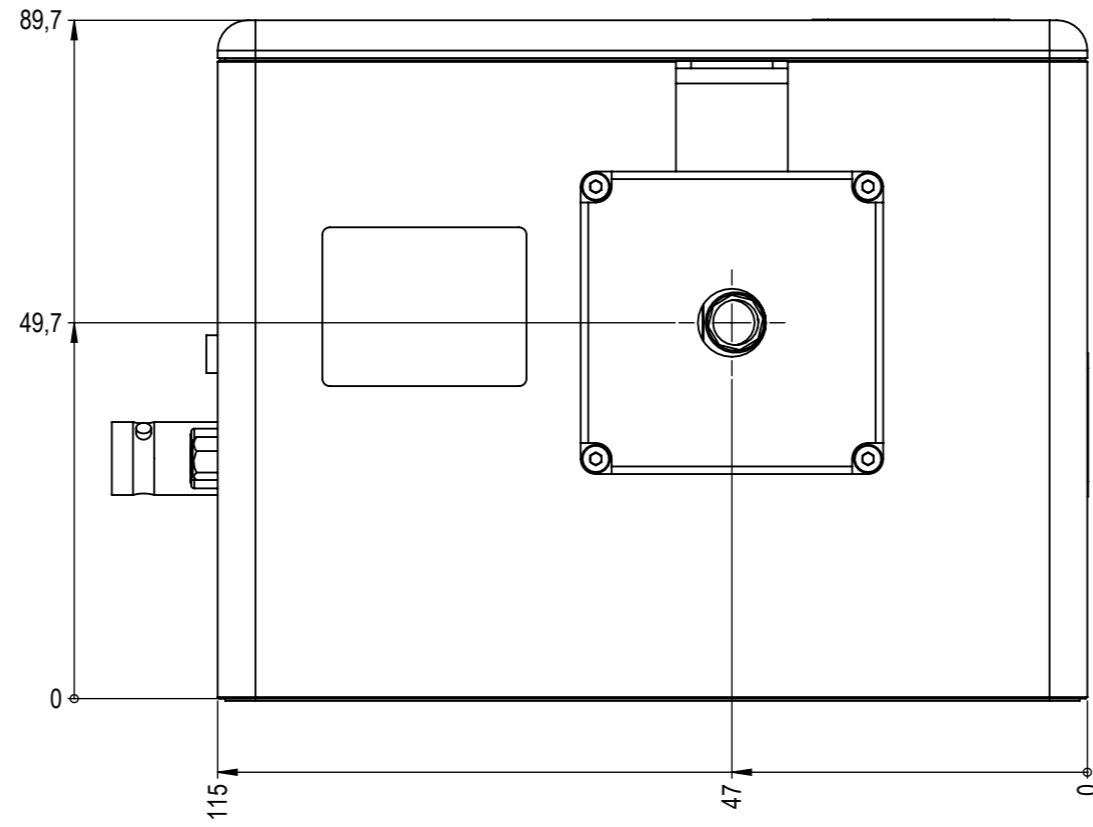

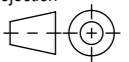
 TOPTICA Photonics AG Lochamer Schlag 19 82166 Grafelfing Tel.: 089-85837-0 Fax.: 089-85837-200 Web: www.toptica.com	title	scale		
	BoosTA pro	1:1		
dimensions are in mm	general tolerance	projection	date	sheet
view BACK	DIN ISO 2768 - mK		20.03.2024	6/8

NOTE: This document is property of the company TOPTICA Photonics AG. All copyrights, trademarks, patents and other rights in connection herewith are expressly reserved to the company TOPTICA Photonics AG and no license is created hereby.

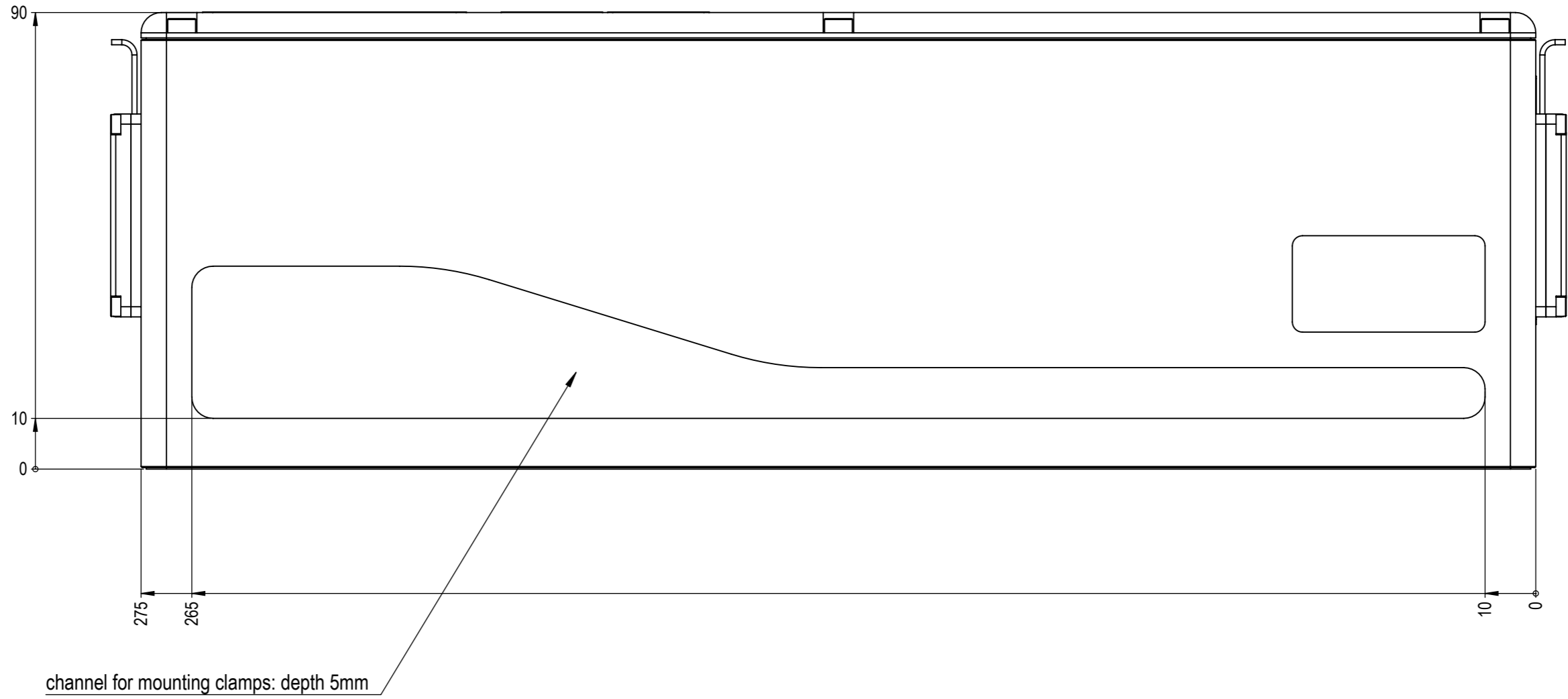

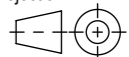
 <small>TOPTICA Photonics AG Tel.: 089-85837-0 Lochhamer Schlag 19 Fax: 089-85837-200 82166 Grafelfing Web: www.toptica.com</small>	title	scale
	BoosTA pro	1:1
dimensions are in mm	general tolerance	projection
view RIGHT	DIN ISO 2768 - mK	
	date	sheet
	20.03.2024	7/8

NOTE: This document is property of the company TOPTICA Photonics AG. All copyrights, trademarks, patents and other rights in connection herewith are expressly reserved to the company TOPTICA Photonics AG and no license is created hereby.

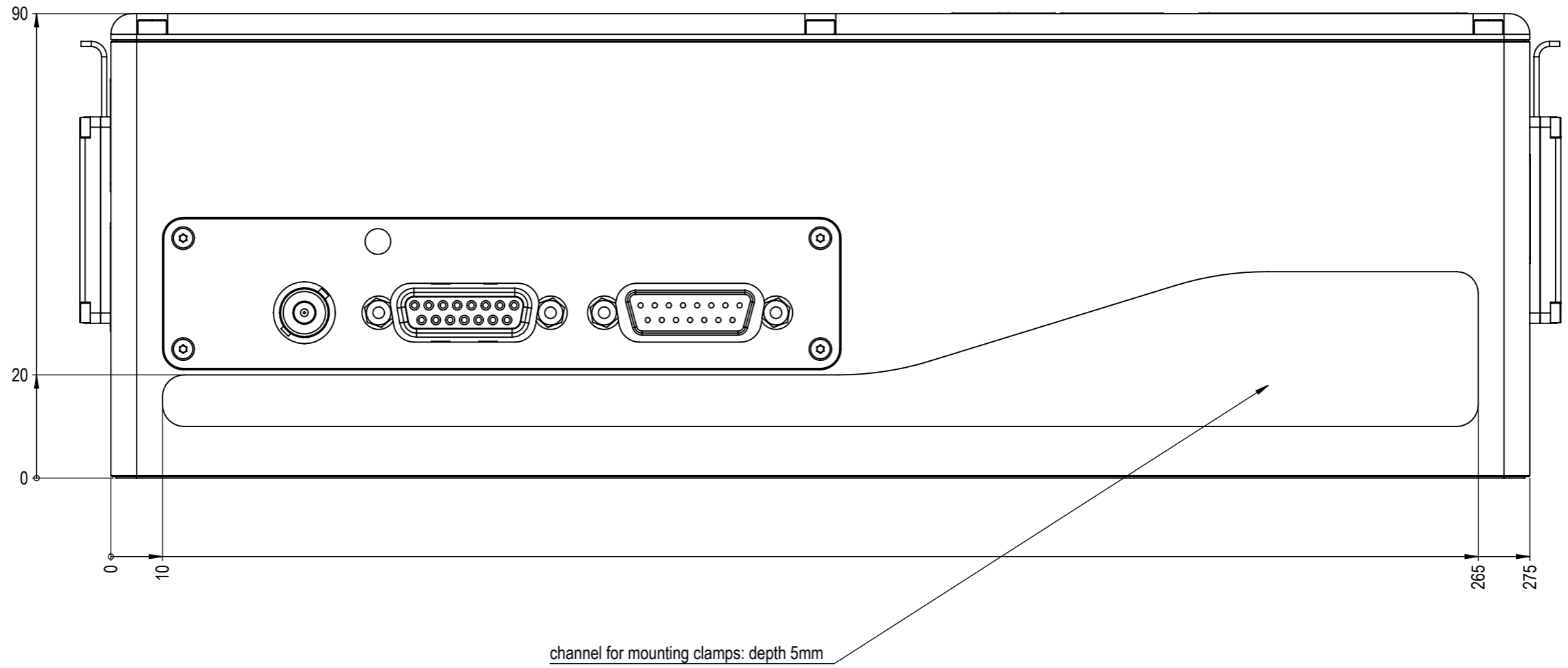

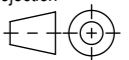
 TOPTICA Photonics AG Lochamer Schlag 19 82166 Grafelfing Tel.: 089-85837-0 Fax.: 089-85837-200 Web: www.toptica.com	title	scale		
	BoosTA pro	1:1		
dimensions are in mm	general tolerance	projection	date	sheet
view LEFT	DIN ISO 2768 - mK		20.03.2024	8/8