

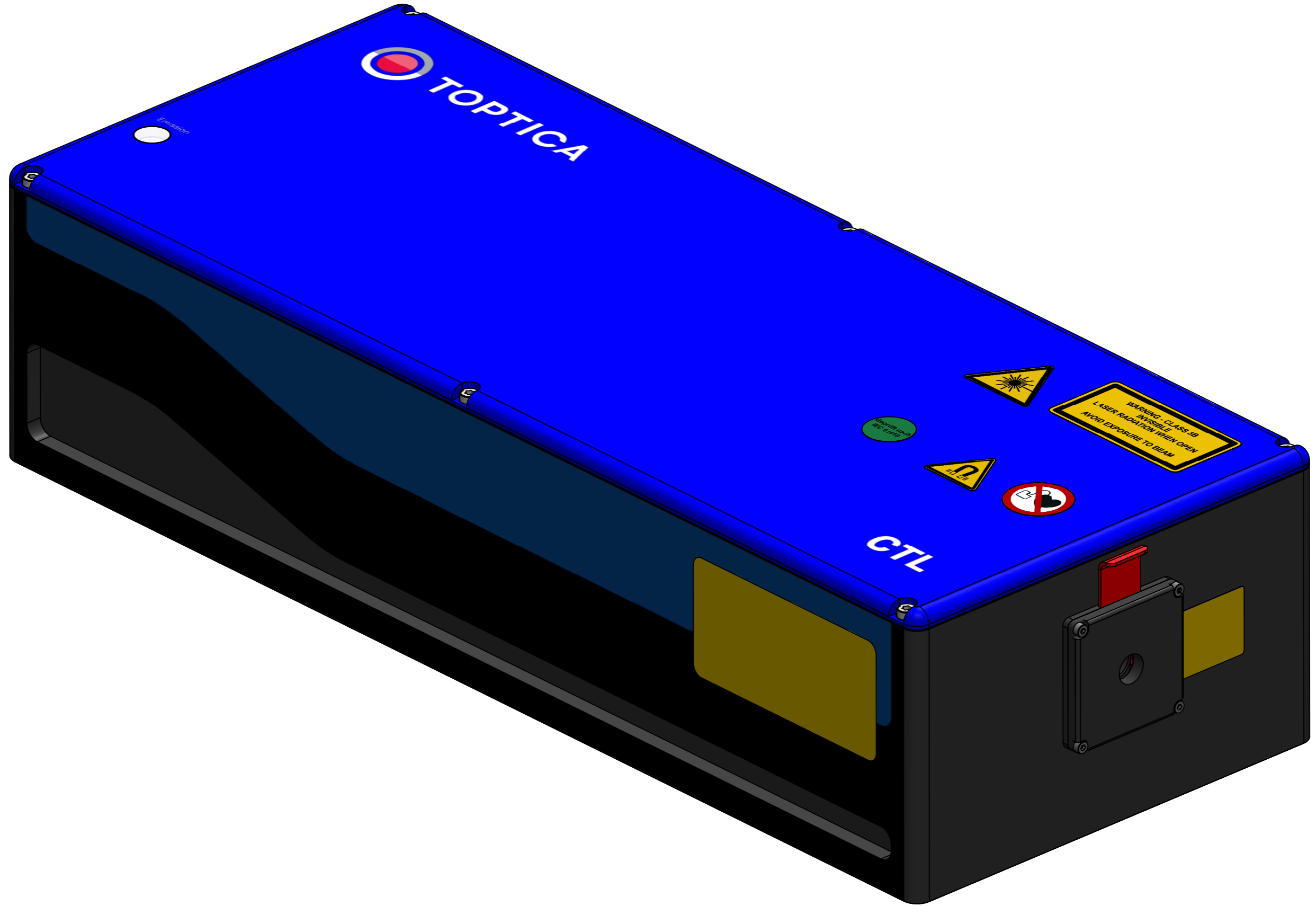



NOTE: This document is property of the company TOPTICA Photonics AG. All copyrights, trademarks, patents and other rights in connection herewith are expressly reserved to the company TOPTICA Photonics AG and no license is created hereby.

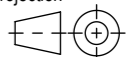
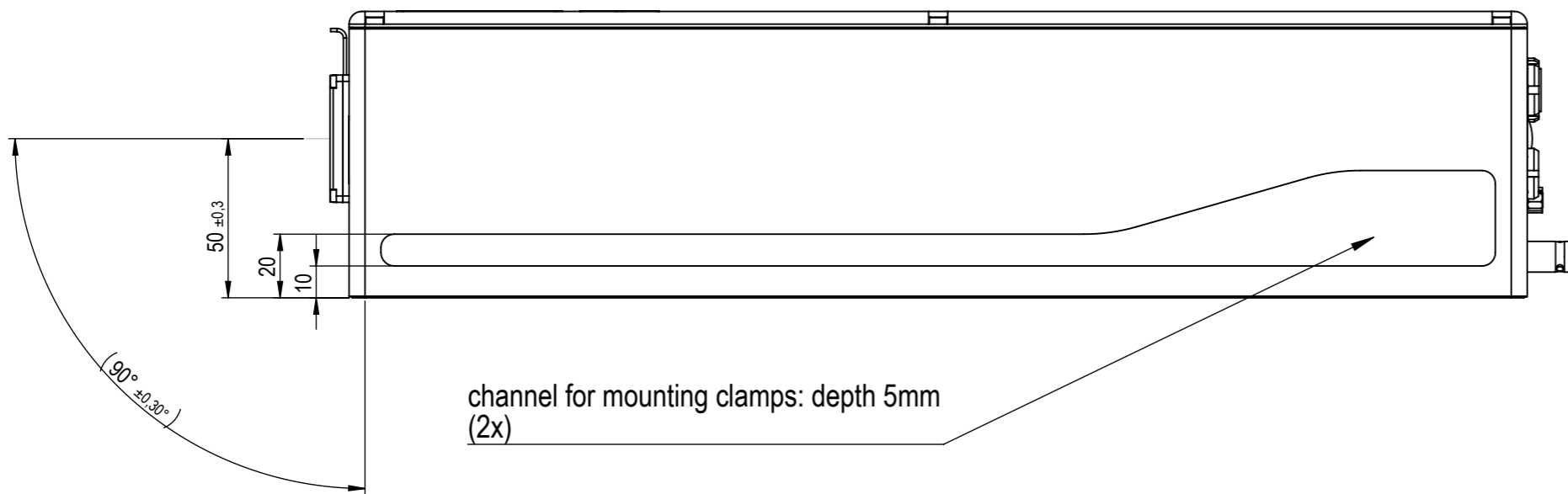
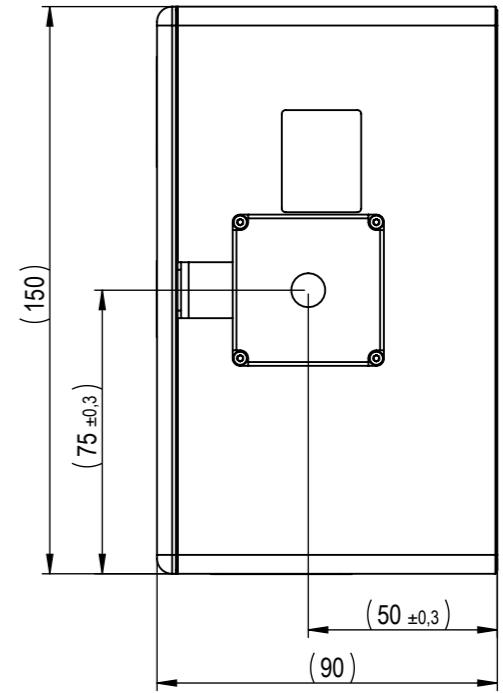
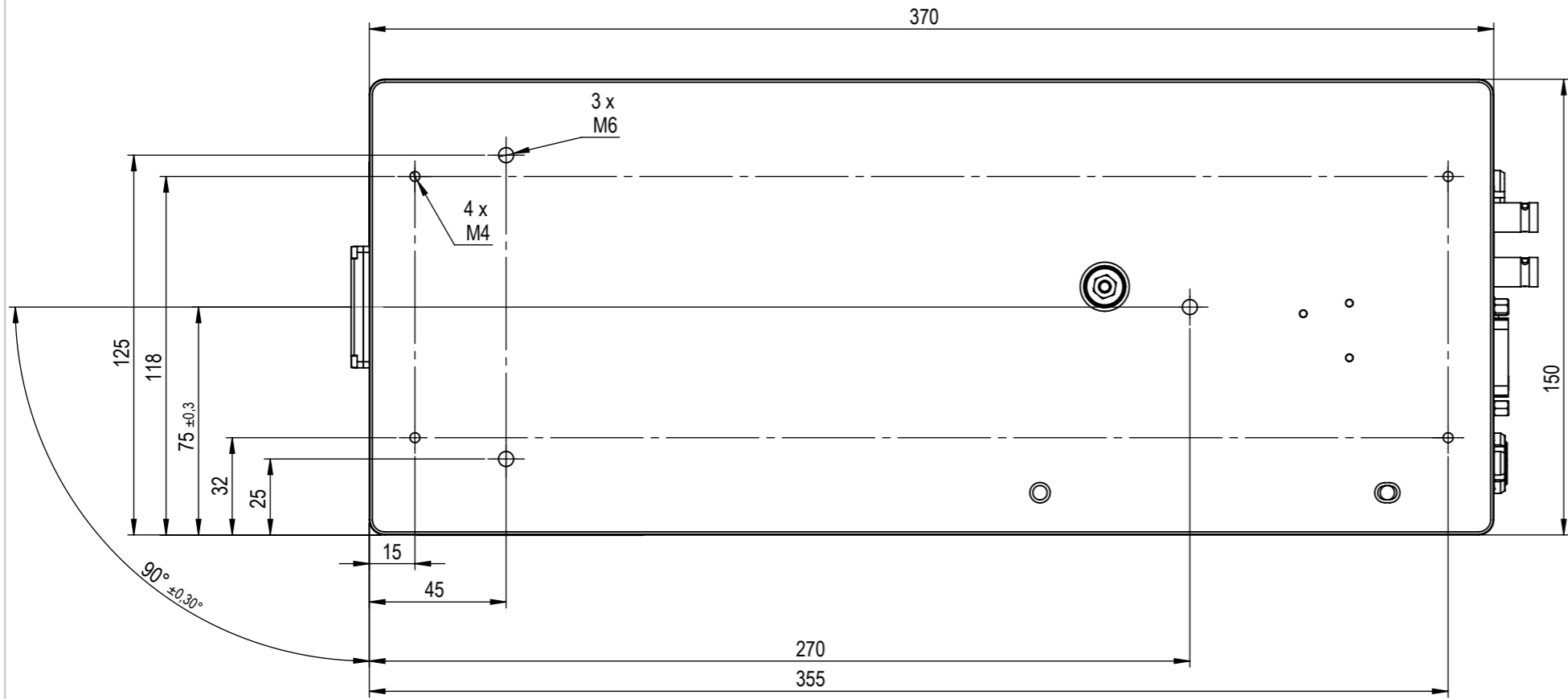

 TOPTICA Photonics AG Lochamer Schlag 19 82166 Grafelfing Tel.: 089-85837-0 Fax.: 089-85837-200 Web: www.toptica.com	title	scale		
	CTL	1:1.5		
dimensions are in mm	general tolerance	projection	date	sheet
view 3D	DIN ISO 2768 - fH		29.05.2024	1/2

NOTE: This document is property of the company TOPTICA Photonics AG. All copyrights, trademarks, patents and other rights in connection herewith are expressly reserved to the company TOPTICA Photonics AG and no license is created hereby.

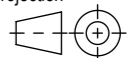

	title CTL	scale
		1:2
TOPTICA Photonics AG Tel.: 089-85837-0 Lochhamer Schlag 19 Fax: 089-85837-200 82166 Grafelfing Web: www.toptica.com	general tolerance DIN ISO 2768 - fh	format
		A3
dimensions are in mm view DRAWINGS	projection 	date 29.05.2024
		sheet 2/2